

Date: _____

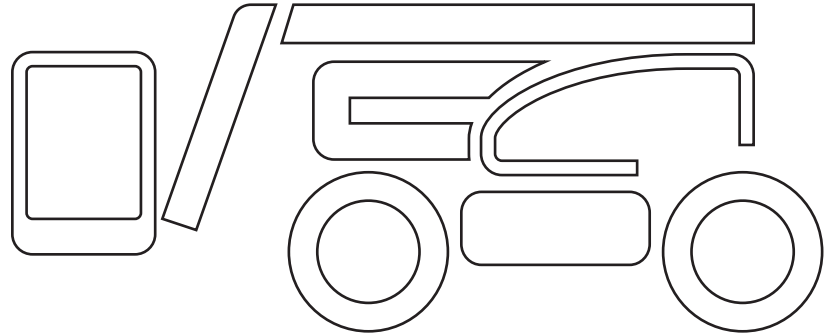

Colour me
nifty
Activity Book

Name: _____

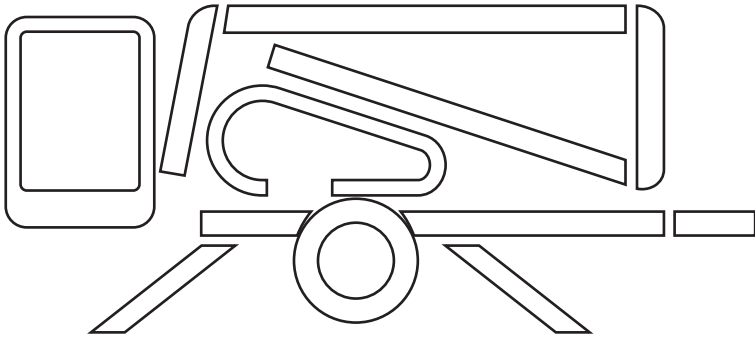
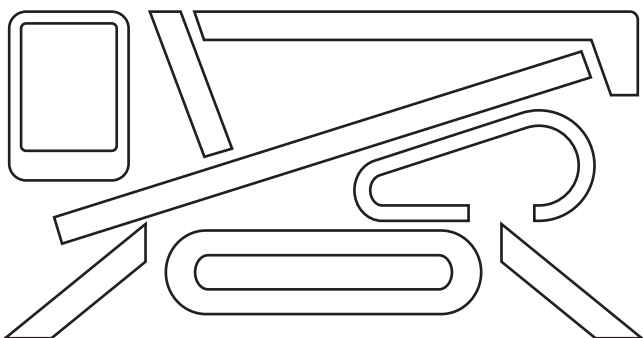
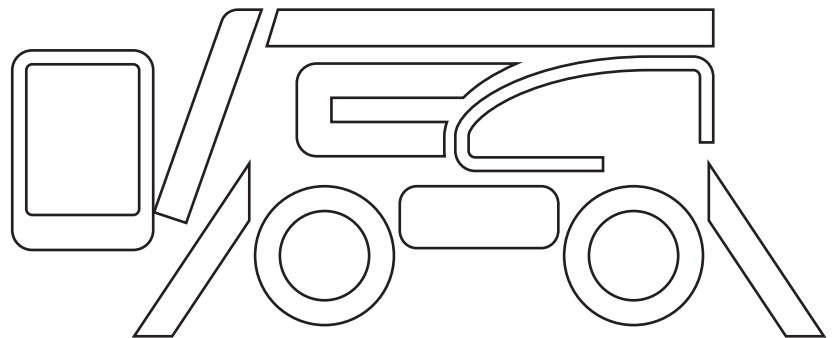

niftylift

Word Search



advanced
basket
bienergy
boomlift
cherry picker

connected
effective
heightrider
hydraulicram
inteligent

manoeuvrable
mobile
niftylift
niftylink
powerful

reliable
stabiliser
trackdrive
trailer mounted
zeroemission



VE DAY

75

Maze

START

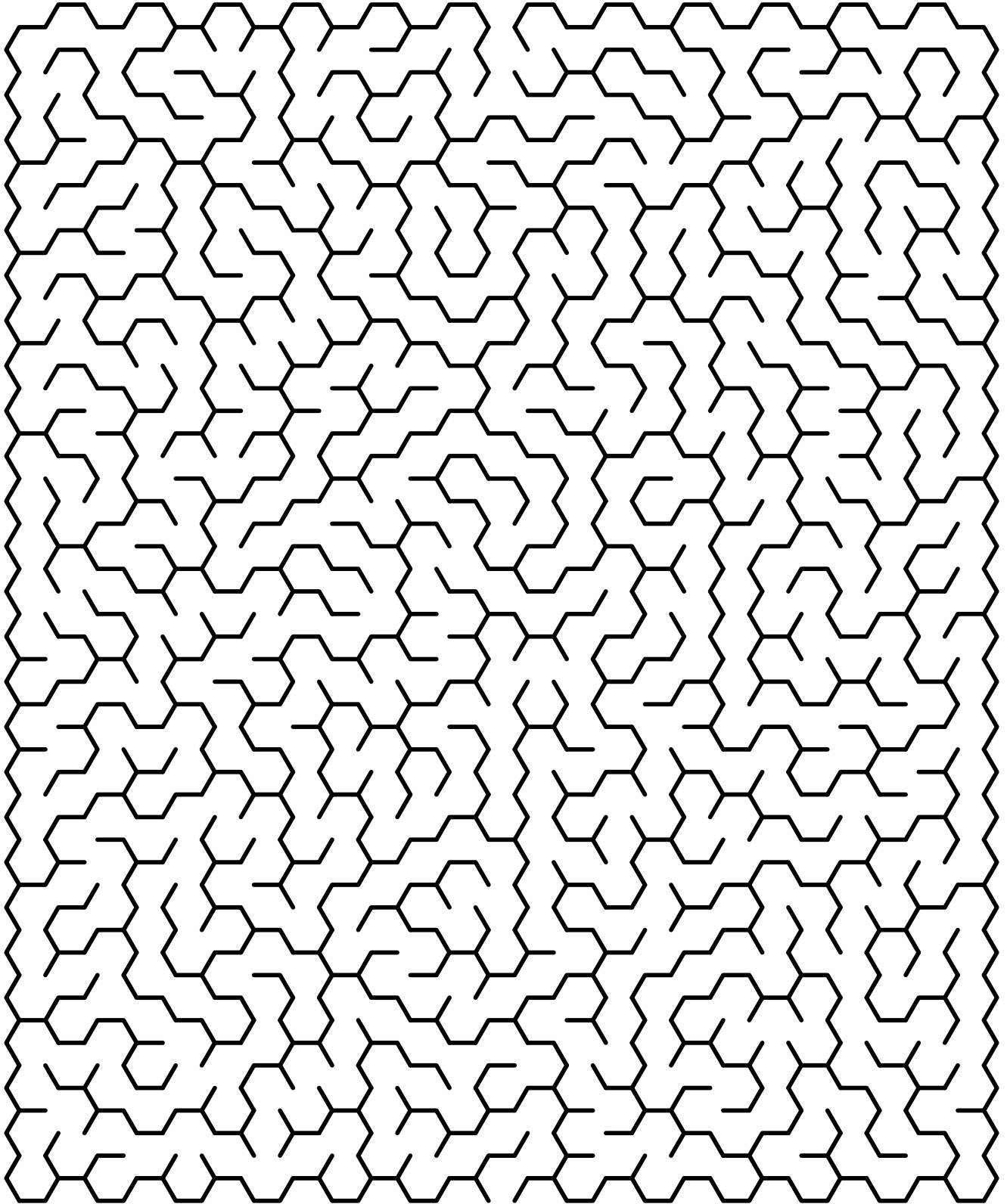

FINISH

Sudoku

Easy

6	7				4	2	9	
		4		2	1			
8		3			7		6	
		6	5					
2				4				3
					6	5		
	3		8			4		7
			2	1		3		
	6	2	4				1	9

Medium

	2	9		6	1	8		4
			8			5		
					7	1		6
	7			3		9		
	6						4	
		3		5				6
5		2	9					
		1			5			
7		6	1	8		3	9	

Hard

8				1				
	6				5	2	1	
1		3	9	8			7	4
	9		6					
	7						8	
					8		2	
9	4			6	7	8		2
	8	1	2				9	
				9				5

Evil

		4			6			7
		8				3		2
2			9				6	5
				5				3
	6	5	7		8	9	2	
7				9				
4	3				9			1
5		7				2		
9			1			7		

WEDNESDAY

7:30

Spot the Diff



Can you find all 10?



Answers

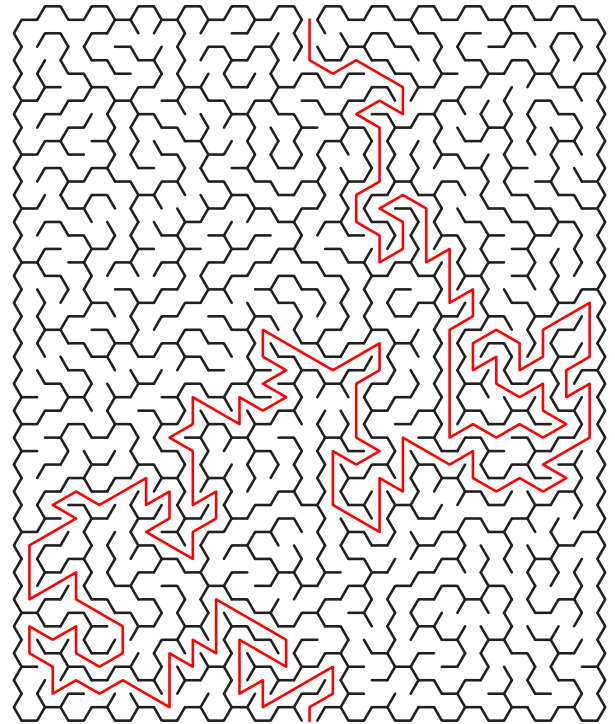
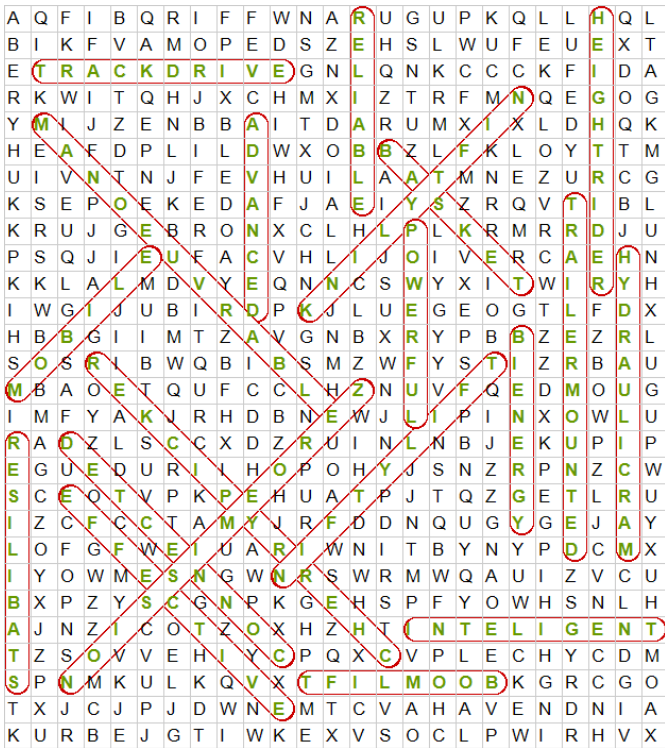

Easy

6	7	1	3	8	4	2	9	5
9	5	4	6	2	1	7	3	8
8	2	3	9	5	7	1	6	4
7	4	6	5	3	2	9	8	1
2	9	5	1	4	8	6	7	3
3	1	8	7	9	6	5	4	2
1	3	9	8	6	5	4	2	7
4	8	7	2	1	9	3	5	6
5	6	2	4	7	3	8	1	9

Medium

3	2	9	5	6	1	8	7	4
6	1	7	8	2	4	5	3	9
4	5	8	3	9	7	1	2	6
1	7	4	2	3	6	9	5	8
8	6	5	7	1	9	2	4	3
2	9	3	4	5	8	7	6	1
5	8	2	9	4	3	6	1	7
9	3	1	6	7	5	4	8	2
7	4	6	1	8	2	3	9	5

Hard

8	2	7	4	1	6	3	5	9
4	6	9	7	3	5	2	1	8
1	5	3	9	8	2	6	7	4
5	9	8	6	2	1	7	4	3
2	7	6	3	4	9	5	8	1
3	1	4	5	7	8	9	2	6
9	4	5	1	6	7	8	3	2
6	8	1	2	5	3	4	9	7
7	3	2	8	9	4	1	6	5

Evil



1	5	4	3	2	6	8	9	7
6	9	8	5	4	7	3	1	2
2	7	3	9	8	1	4	6	5
8	4	9	6	5	2	1	7	3
3	6	5	7	1	8	9	2	4
7	2	1	4	9	3	6	5	8
4	3	6	2	7	9	5	8	1
5	1	7	8	6	4	2	3	9
9	8	2	1	3	5	7	4	6

Please contact marketing@niftylift.com with any questions, comments or suggestions.